



Society for Environmental Graphic Design
www.segd.org

SEGD 2012 ADA Update

Signage Requirements in the 2010 Standards for Accessible Design

October 2012

Contents

iii	DEDICATION
iv	ACKNOWLEDGEMENTS
1	INTRODUCTION
2	1.0 INTERIOR SIGNS
2	1.1 Summary and Exemptions
4	1.2 Finish and Contrast for Raised and Visual Characters
4	1.3 Typographical and Pictogram Requirements
5	1.3.1 Signs Identifying Permanent Rooms and Spaces (§216.2)
5	Standard Location (§703.4)
6	When Mounting Space is Not Available (§703.4.2)
7	At Double Doors (§703.4.2)
7	At Doors Opening Outward into the Path of Travel (§703.4.2)
8	On the Door Itself (§703.4.2)
9	1.3.2 Braille and Raised Characters
9	Braille (§703.3)
11	Raised Characters (§703.2)
11	General Characteristics
11	Finish and Contrast
11	Raised Character Size
11	Raised Character Stroke Thickness
11	Raised Character Proportions
12	Raised Character Spacing
12	Line Spacing
13	Acceptable Raised Character Typefaces
14	1.3.3 Visual Characters (§703.5)
14	General Characteristics
14	Finish and Contrast
14	Visual Character Size
15	Visual Character Stroke Thickness
15	Visual Character Proportions
16	Visual Character Spacing
16	Line Spacing
17	Acceptable Visual Character Typefaces
17	1.3.4 Signs with Combined Raised and Visual Characters
18	1.3.5 Signs with Separate Raised and Visual Characters
19	1.3.6 Pictograms Required in Special Instances (§§216.2, 703.6.1)

Note: Section numbers (example: §703.4) referring to the sections of the Standards for Accessible Design (SAD) are provided for reference throughout this document.

20	1.3.7	Symbols of Accessibility (§§213.2 Exception 3, Advisory 216.2, 216.4 – 216.12, 502.6, 703.7)
20		International Symbol of Accessibility (§§213.2 Exception 3, Advisory 216.2, 216.4 – 216.8, 216.11, 216.12, 502.6, 703.7.2.1, 703.7.2.1)
22		TTY's (Text Telephones, §§216.8, 703.7.2.2)
22		Volume Control Telephones (§§219.9, 703.7.2.2)
23		International Symbol of Hearing Loss (§§216.10, 703.7.2.4)
23	1.3.8	Other Interior Visual Signs
23		Overhanging and Protruding Objects (§307.2)
24		Post-Mounted Objects (§307.3)
25	2.0	SPECIAL SIGN SITUATIONS
25	2.1	Exit Doors (§216.4.1)
25	2.2	Areas of Refuge (§216.4.2)
27	2.3	Entrances (§216.6)
28	2.4	Elevators (§216.7)
28	2.5	Toilet and Bathing Rooms (§216.8)
29	2.6	TTYs (§216.9)
29	2.7	Assistive Listening Systems (§216.10)
30	2.8	Check-Out Aisles (§216.11)
30	2.9	Amusement Rides (§216.12)
31	2.10	Floor Designation on Elevator Door Jambs/Hoistways (§4072.3.1)
31	2.11	Car Designation on Elevator Door Jambs/Hoistways (§4072.3.2)
33	3.0	EXTERIOR SIGNS
33	3.1	Introduction
33	3.2	Accessible Parking Signs (§§502.6, 216.5)
34	4.0	CALCULATIONS
34	4.1	Contrast Calculations
34	4.2	Measuring Raised and Visual Characters
34	4.3	Measuring Raised and Visual Character Proportions
35	4.4	Measuring Raised Character Stroke Thickness
35	4.5	Measuring Raised Character Spacing
35	4.6	Measuring Visual Character Stroke Thickness
35	4.7	Measuring Visual Character Spacing
36	5.0	FREQUENTLY ASKED QUESTIONS
41	6.0	APPENDIX: ADDITIONAL ACCEPTABLE TYPEFACES

Dedication



Dedicated to Hanley Bloom (1936-2011)

The SEGD 2012 ADA Update is dedicated to the memory of Hanley Bloom, industry pioneer and co-founder of ASI Sign Systems with his twin brother, Stanley.

Hanley was a supporter of SEGD from the very beginning, serving on the Board of Directors and contributing mightily and materially every time it was really needed.

His list of accomplishments and innovations will impress both veteran and new members of the profession or industry alike.

If you didn't know him, ask someone who did. You will receive a lesson in living a complex life.

Old friend, you left too soon. There's still much to do.

-- Ken Ethridge

Acknowledgements

SEGD ADA Committee

Many SEGD members have served on the SEGD ADA Committee since its inception in the late 1980s as the ADA Code Committee, and we gratefully acknowledge their contributions. Committee members who contributed to the SEGD 2012 ADA Update include:

Ken Ethridge, AIA, Ethridge & Company (principal author)
Chris Calori, Calori & Vanden-Eynden / Design Consultants
Teresa Cox, APCO Graphics
Grady Brown, GtB Consulting
Patty Hudson, APCO Graphics
Dave Miller, Nova Polymers
Matt Williams, Dixie Graphics
Max Heim, Studio L'Image
Roger Whitehouse, Whitehouse & Company
Ben Whitehouse, Whitehouse & Company

Document / Illustration Production: Steve Reinisch, TheGreatDetailGuy!

We gratefully acknowledge the support of our sponsors:



Lead Sponsor
ASI Signage Innovations
www.asisignage.com



Sponsor
APCO Graphics
www.apcosigns.com

About SEGD

Founded in 1973, SEGD (the Society for Environmental Graphic Design) is the global community of people working at the intersection of communication design and the built environment. Through educational programs, research, and publications, SEGD's mission is to provide learning opportunities and resources for professionals involved in environmental graphic design, promote the importance of the discipline in establishing place, and continue to refine standards of practice for the field. For more information, visit www.segd.org.

The technical assistance provided in this document is intended solely as informal guidance and a useful reference with regard to the subject of evolving Federal accessibility standards that apply to signage and wayfinding design. The information presented is subject to interpretation, and may include observations, opinions, and other material inherently subjective in nature. Design professionals are responsible for independently verifying compliance of specific design elements with all applicable Codes and Standards. The governing building and fire code authorities should be contacted for interpretations applicable to any specific design. The content in this presentation is made available "as is," without warranty of any kind or claims of fitness for any particular purpose, and with the understanding that the Society for Environmental Graphic Design (SEGD) and the authors of this document are not engaged in rendering legal or other professional service by presenting this information, nor do they assume liability for errors, omissions, or any damage (whether direct, indirect, consequential, or incidental) resulting from its use or interpretation. If legal or other professional advice is required, the services of a competent professional should be sought.

Introduction

The Americans with Disabilities Act (ADA), the enabling legislation, was signed into law by President George H. Bush on July 26, 1990. Its purpose was to make illegal any discrimination against the disabled in access to goods, services, and employment. Its supporting technical guidelines, the Americans with Disabilities Act Accessibility Guidelines (ADAAG), were issued on July 26, 1991, and were made effective on January 26, 1992.

The ADA is an extension of the landmark 1964 Civil Rights Act that made it illegal to discriminate against any person on the basis of race, religion, sex, national origin, and other characteristics. Much of the language of the ADA reflects the original 1964 Act.

The language of the ADA law is very clear when it places responsibility for conformance to the law very firmly on the owner of the project. Designers, manufacturers, and others who act as agents of the project owner must be knowledgeable in the detailed aspects of the accessibility guidelines as part of their responsibility to the owner.

Although the ADA and ADAAG profoundly affect sites and buildings in the United States, neither document was conceived as a “national building code.” Rather, they represent something new in American jurisprudence, the application of civil rights statutes to the built environment. Therein lies the confusion that still exists regarding exactly how the requirements are applied.

The updated ADAAG (called the Standards for Accessible Design, or SAD) were effective on March 15, 2011, for the construction and alteration of facilities covered by the ADA, including places of public accommodation, commercial facilities, and state and local government facilities. These new requirements represent the first major change to the technical guidelines. They will most likely be the format and base content for years to come.

When the Department of Justice released SAD, it gave additional guidance on when projects still under design are required to follow the new standards. Refer to Chapter 5.0, Frequently Asked Questions, for this information.

Airports, train stations, and bus depots covered by the Department of Transportation and Federal property governed by the General Services Administration or the Department of Defense have already adopted the SAD and have been following them for several years.

The SAD includes substantial changes and additions to the requirements for accessible signage. The signage section is significantly longer than in the 1991 ADAAG.

The purpose of the SEGD 2012 ADA Update is to help the EGD community meet the spirit and intent of the new SAD accessible guidelines.

Interior Signs | 1.0

1.1 Summary and Exemptions

The Standards for Accessible Design (SAD) define two categories of signs:

1. Signs identifying a permanent room or space (§216.2).
2. Signs giving directions to or information about permanent rooms or spaces (§216.3).

Signs identifying a permanent room or space (“identification” signs) are required to use Raised Characters and Braille and must be mounted in a consistent location: on the wall, next to the door, on the latch (“strike”) side with some exceptions. Directional and informational signs, however, are not required to be in a consistent location and require only Visual Characters.

In certain special circumstances (i.e., “combined” signs), signs identifying a permanent room or space may employ only Visual Characters as long as a separate sign or insert with Raised Characters and Braille is also provided.

As noted in the SAD Scoping Requirements for signage, certain sign types are completely exempted from SAD requirements because of their changeable nature (§216.1):

- Building directories
- Menus
- Seat and row designations in assembly areas
- Occupant names
- Building addresses
- Company names and logos
- Temporary signs (7 days or less)
- Signs in detention and correctional facilities not located in public-use areas
- Signs in Parking Facilities (except egress signs)

The Scoping Requirements chapter is often overlooked, because it is located in another part of the SAD (and in the ADAAG before it). But the Scoping chapter is just as important as the areas describing the actual signage standards (§703), because it is the only place in the SAD that denotes exactly which requirements apply to what types of signs. In addition to exceptions, it also contains important examples, definitions, and advisories.

Even code officials sometimes overlook the Scoping Requirements for signage and attempt, for example, to enforce Raised Characters and Braille on visual signs where their use was never intended.

See chart, next page.

Summary: SAD Requirements for Interior Signs

		Identification/ Information/ Directional
Raised Characters		
Style	Sans serif only; no italic, oblique, script, or highly decorative fonts	•
Case	Upper-case characters only	•
Height	5/8" minimum to 2" maximum, based on "I" height	•
Depth	Raised 1/32" minimum above sign surface	•
Stroke Thickness	15% maximum of "I" height	•
Proportions	Width of uppercase "O", 55% to 110% of uppercase "I" height	•
Character Spacing	1/8" minimum to 4x stroke width maximum	•
Line Spacing	Baseline to baseline: 135% to 170% of "I" height within a message	
Clearance	Separated 3/8" minimum from Braille, raised borders, and decorative elements	•
Mounting Location	Wall adjacent to door on strike side, 48" – 60" to Raised Character baseline	•
Visual Characters		
Style	Serif or sans serif; no italic, oblique, script, or highly decorative fonts	•
Case	Upper case and lower case	•
Height	5/8" minimum to 3"+, based on height from finished floor and viewing distance	•
Stroke Thickness	10% – 30% of "I" height	•
Proportions	Width of upper case "O", 55% to 110% of upper case "I" height	•
Character Spacing	10% of stroke width minimum, 35% maximum	•
Line Spacing	Baseline to baseline: 135% to 170% of "I" height within a message	•
Braille		
Type	Contracted Grade 2 Braille	•
Location	Directly below its corresponding Raised Characters	•
Multi-line Messages	If Raised Character text is multi-lined, Braille is placed all together	•
Clearance	Separated 3/8" minimum from Raised Characters, raised borders, or decorative elements	•
Shape	Braille dots must always be domed or rounded, never flat or pointed	•
Pictogram		
Field Height	Required field height of 6" minimum with no other elements present within it	•
Pictogram Height	Relative size of pictogram image within 6" high field at designer's discretion	•
Text Position	Raised Character descriptive text is placed below (not within) the pictogram field	•
Braille Position	Braille is placed below its corresponding Raised Character descriptive text	•
Overhead and Protruding Objects		
Overhead Clearance	Minimum 6'-8" (80")	•
Protruding Objects	Mounted 27" – 80" from floor may extend into the circulation path a maximum of 4"	•
Accessible Parking Identification		
ISA	International Symbol of Accessibility (ISA) must appear on the sign	•
Van Accessible	Signs identifying van parking places must include the text "Van Accessible"	•
Mounting	60" minimum from ground surface to bottom of sign	•
Finish and Contrast		
Finish	Characters and backgrounds must have a non-glare finish	• •
Contrast	Visual Characters and backgrounds must contrast, either light on dark or dark on light	• •

1.2 Finish and Contrast for Raised and Visual Characters

All signs are required to have a non-glare finish and both Raised and Visual Characters are required to contrast with their background, either dark-against-light or light-against-dark, unless separate Raised and Visual Characters are provided.

Although contrast requirements are not specifically outlined in the standards, good contrast between characters and pictograms is extremely important for accessibility and legibility. The ADAAG's recommendation for 70% contrast, calculated by comparing Light Reflectance Values (LRV) of the image and background colors, is not included in SAD, but is still a valid rule of thumb. The method for calculating contrast using LRV is explained in Chapter 4.0, Calculations.

Research indicates that signs are more legible for persons with low vision when characters contrast with their background by at least 70%.

1.3 Typographical and Pictogram Requirements for Raised and Visual Characters

Note: The term "tactile characters" refers to characters that are read by touch, which includes both Raised Characters and Braille. "Raised Characters" are defined as relief versions of the easily recognized Latin/Roman alphabet (Aa, Bb, Cc, etc.) used in the English language.

See chart, next page.

Overview of Requirements/Guidelines for Raised and Visual Characters

Characteristic	Raised Characters	Visual Characters
Depth	Raised 1/32" minimum above sign background	Not required to be raised above sign background
Case	Upper case only	Upper and/or lower case
Style	Sans serif only No italic, oblique, script, highly decorative, or other unusual fonts.	Serif or sans serif No italic, oblique, script, highly decorative, or other unusual fonts.
Proportions		
Character Width	"O" 55% to 110% based on height of "I"	"O" 55% to 110% based on height of "I"
Character Height	5/8" to 2", based on height of "I"	Varies principally with height of character baselines to finished floor or ground level: <ul style="list-style-type: none"> • 5/8" minimum between 40" and 70" • 2" minimum between 70" and 120" • 3" minimum above 120" Note: SAD also defines incremental character heights per foot of horizontal viewing distance.
Stroke Thickness	Stroke of "I" 15% maximum of "I" height; 10% recommended minimum	Stroke of "I" 10% to 30% of "I" height
Character Spacing	1/8" minimum to 4x stroke width maximum	10% to 35% of "I" height
Line Spacing	Baseline to baseline within a multi-lined message: 135% to 170% of "I" height	Baseline to baseline within a multi-lined message: 135% to 170% of "I" height

Source: Calori & Vanden-Eynden / Design Consultants

1.3.1 Signs Identifying Permanent Rooms and Spaces (§216.2)

Standard Location (When doors open into a room or space) (§703.4)

- Signs identifying a permanent room or space must be mounted on the wall, next to the door, on the latch ("strike") side so that the sign's location relative to the door hardware is predictable for a blind or severely visually disabled person.
- Signs can be mounted within a range of heights from the finished floor, allowing different-sized signs to be displayed at a consistent height along a wall, or enabling mounting at a more useable height in children's facilities.
- The baselines of Raised Characters must be located between 48" (lowest Raised Character) and 60" (highest Raised Character) above the finished floor.

Standard Sign Location

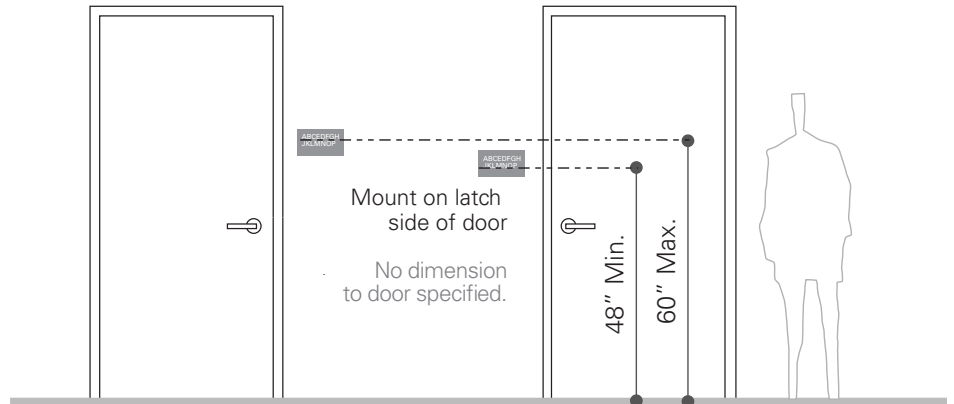

When Mounting Space Is Not Available (§703.4.2)

- When there is no room for the sign on the strike side of the door, it can be placed on the nearest adjacent wall.

When Mounting Space Is Not Available

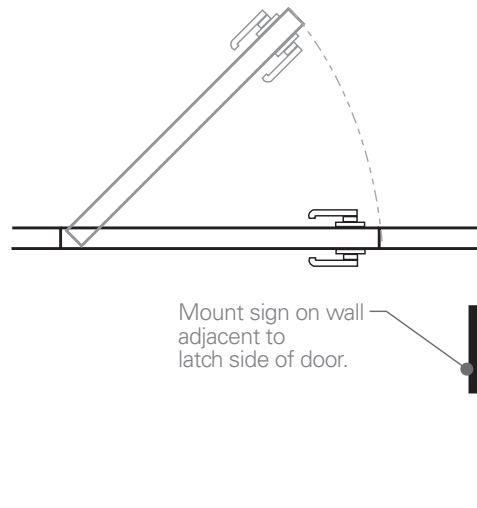

At Double Doors (§703.4.2)

- If only one door is operable, the sign must be mounted to the inactive door.
- If both doors are operable, the sign must be mounted to the right of the right-hand door.
- If there is no space for the sign on the right side of the door, it can be placed on the nearest adjacent wall.

At Double Doors

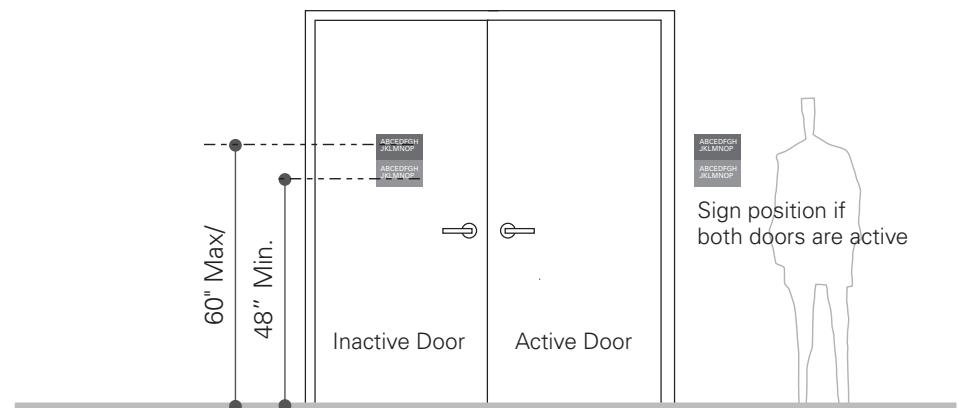

At Doors Opening Outward into the Path of Travel (§703.4.2)

- The safety of the tactile reader is paramount. To protect the reader from an outward swinging door, in the less common condition where a door opens out into the corridor or accessible path of travel, the sign must be mounted outside of the arc of the door swing.
- In these situations, the Raised Characters on an identification sign must be centered within an 18" square, clear floor space.
- The resulting distance from the door frame is therefore determined by the width of the sign. Thankfully, this situation is unusual in new construction.

See illustration, next page.

At Doors Opening Outward into the Path of Travel

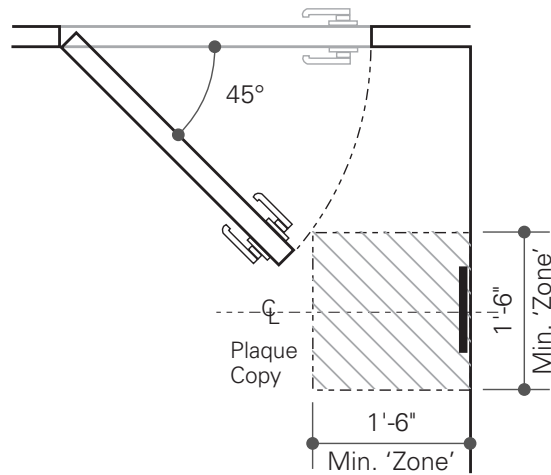

On the Door Itself (§703.4.2)

An identification sign may be mounted onto the door itself only if all three of these conditions are met:

- The sign is mounted on the "push" side of the door that opens into the room.
- The door has a power closer.
- The door has no hold-open device.

Examples could include doors leading to restrooms, hotel rooms, and the occupancy side of fire exit doors.

On the Door Itself

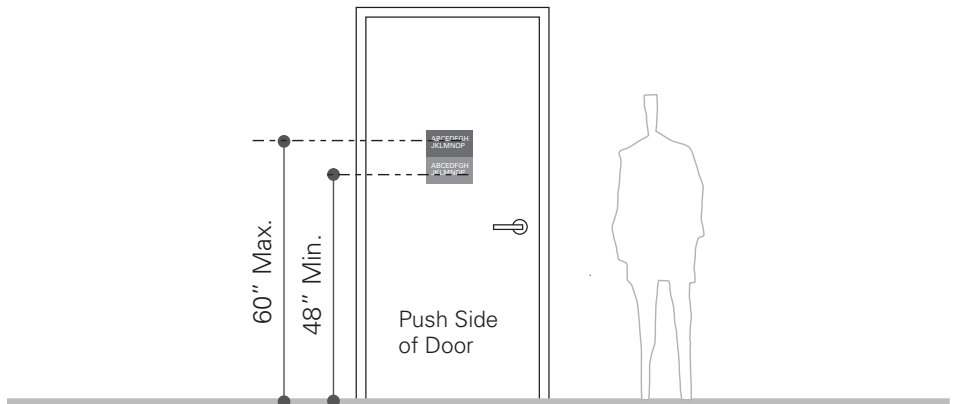

1.3.2 Braille and Raised Characters

Text on signs identifying permanent rooms or spaces must appear in both Braille and Raised Characters.

Braille (§703.3)

According to SAD, Braille must be:

- Contracted Grade 2 Braille
- Located directly below corresponding Raised Characters
- When Raised Character text is multi-lined, must be placed below entire text and separated by a minimum of 3/8" from any other Raised Characters and 3/8" minimum from raised borders and decorative elements
 - Include dots that are domed or rounded
 - Use lower-case letters, except for upper case for the first word of sentences, proper nouns and names, individual letters of the alphabet, and acronyms

By now, most designers and fabricators are familiar with Braille and how it should be specified and used. Grade 2 Braille is required for accessible signage.

Grade 1 Braille is character-for-character, one Braille character for each English character.

Grade 2 Braille (Library of Congress or Contracted Braille), however, includes additional characters and character combinations that represent contractions of words and word components, such as "the" and "-ation." Consequently, considerable care must be taken to translate Grade 2 Braille correctly. Using a computer-based program is recommended. It is also recommended that a Braille proofreader approve all final artwork.

Braille is read with the pad of the finger, not the tip, so no obstructions such as dimensional frames or decorative features should prevent the finger from lying flat against the sign face. That is the reason for the requirement for 3/8"

Braille | Grade 2 | Numbers

1 2 3 4 5 6 7 8 9 0
⠠⠠ ⠠⠠ ⠠⠠ ⠠⠠ ⠠⠠ ⠠⠠ ⠠⠠ ⠠⠠ ⠠⠠ ⠠⠠

Braille | Grade 2 | Identifiers

⠠⠠ Number follows ⠠⠠⠠⠠ = 45 ⠠⠠ Capital letter follows ⠠⠠⠠⠠ = Ken ⠠⠠ Blank 'cell' signals a space
d + e k + e + n

Raised Characters (§703.2)

SAD includes the following requirements for Raised Characters:

General Characteristics

- Only sans serif styles with normal to thin strokes for ease of tactile reading.
- Only upper case characters; simpler upper case letterforms are easier to read tactilely
- No serif, italic, oblique, script, or highly decorative typefaces permitted.

Finish and Contrast

- Raised Characters and their background must have a non-glare finish.
- Characters must be light on a dark background or dark on a light background unless Raised Characters are accompanied by separate Visual Characters, in which case, Raised Characters do not have to contrast with background.
 - Although it is no longer a requirement, a minimum of 70% contrast between characters and background is recommended.
 - See Chapter 4.0, Calculations, for an explanation of how to calculate contrast using the Light Reflectance Values (LRV) of different colors.

Raised Character Size

- Limited to between 5/8" and 2" in height, raised a minimum of 1/32" above the background
- Exception: If separate Visual Characters are provided, Raised Characters can be 1/2" high and do not need to contrast with background (see §1.3.5).

Raised Character Stroke Thickness

- Regular or normal weights of most typefaces will fall within the stroke thickness range permitted by the SAD:
 - Stroke thickness 15% or less of "X" (cap "I" height); no less than 10% recommended by SEG D
- Check to make sure, using the method shown in Chapter 4.0, Calculations.

Raised Character Proportions

- Some condensed and extended typefaces in some weights will be accommodated within the character range permitted by the SAD:
 - Character width of "O" 55% to 110% of "X" (cap "I") height
- Check to make sure, using the method shown in Chapter 4.0, Calculations
- Character proportion requirements are the same for both Raised and Visual Characters.

Raised Characters | Stroke Thickness and Character Proportions

10% X min.
(No min. required, but SEGD
recommends no less than 10%)

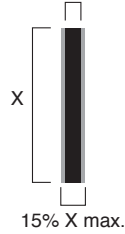

**Raised Character
Stroke Thickness**

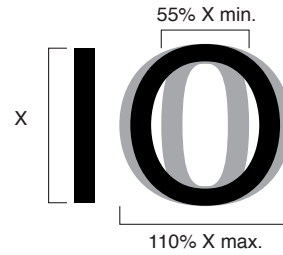

Character Proportions
55% to 110% of
"X" (Cap "I" Height)

**Raised Character
Proportions**

Raised Character Spacing

- Distance between characters must be a minimum of 1/8" and a maximum of 4 times the character stroke width.
- Distances are measured between the closest points of adjacent characters.
- Characters must be separated from Braille, raised borders, and decorative elements by 3/8" minimum.
- See Chapter 4.0, Calculations, for spacing determination.

Raised Characters | Spacing

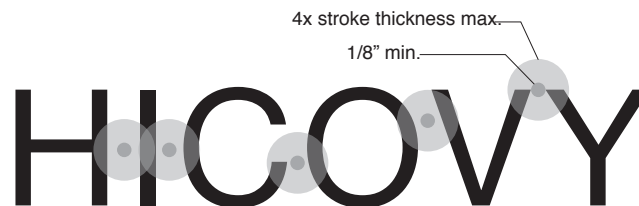

Line Spacing

- Spacing between lines of copy within a message must be a minimum of 135% and a maximum of 170% of the corresponding uppercase "I" height (measured from baseline to baseline).
- Line spacing requirements are the same for both Raised and Visual Characters.
- To more effectively distinguish between multiple messages on one sign, line spacing between each message can be greater than 170%.

Raised Characters | Multiple Line Spacing

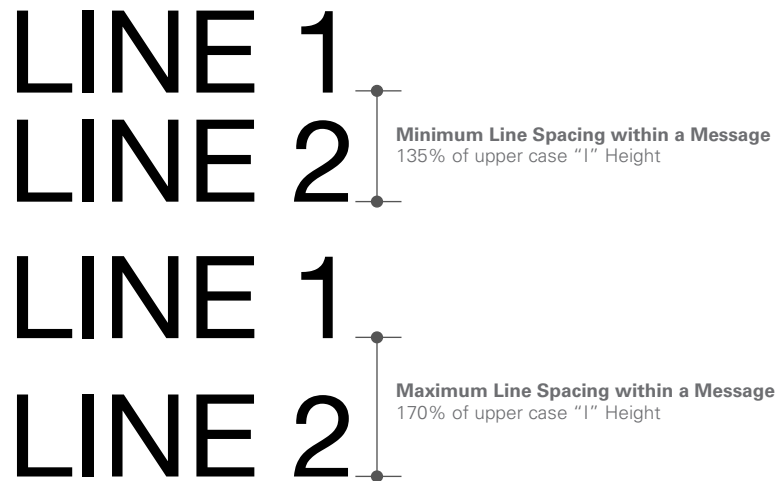

Acceptable Raised Character Typefaces

Note: These are only a few of the many acceptable Raised Character typefaces.

Acceptable Raised Character Typefaces | Samples

Avenir Roman

ABCDEFGHIJKLMN OP 1234567890

ITC Franklin Gothic Book

ABCDEFGHIJKLMN OP 1234567890

Frutiger 55 Roman

ABCDEFGHIJKLMN OP 1234567890

Gill Sans Regular

ABCDEFGHIJKLMN OP 1234567890

Helvetica LT Std Roman

ABCDEFGHIJKLMN OP 1234567890

Myriad Pro Condensed

ABCDEFGHIJKLMN OPQRSTUVWXYZ 1234567890

Univers 57

ABCDEFGHIJKLMN OPQRSTUVWXYZ 1234567890

1.3.3 Visual Characters (§§216.3, 703.5)

Signs providing directions to, or information about permanent rooms or spaces are only required to display Visual Characters. SAD requirements for Visual Characters also apply to Raised and Visual Characters on signs identifying permanent rooms and spaces, unless separate Raised and Visual Characters are provided (see 1.3.5).

General Characteristics

- Visual Characters may be serif or sans serif.
- No italic, oblique, script, or highly decorative typefaces permitted
- Visual Characters may be either upper or lower case or a mixture of the two.

Finish and Contrast

- Visual Characters and their background must have a non-glare finish.
- Characters must be light on a dark background or dark on a light background.
- Although it is no longer a requirement, a minimum of 70% contrast between characters and background is recommended.
- See Chapter 4.0, Calculations, to calculate contrast using the Light Reflectance Values of different colors.

Visual Character Size

- Visual Characters are sized in relation to 1) the height of their baseline off the finished floor and 2) the uninterrupted horizontal access of the sign.
- Visual Characters must be located 40" minimum above the finished floor or ground.
- Visual Characters located on overhead signs (required minimum clearance 80") may use 2" characters rather than 3" as previously required.

Visual Characters | Sizes

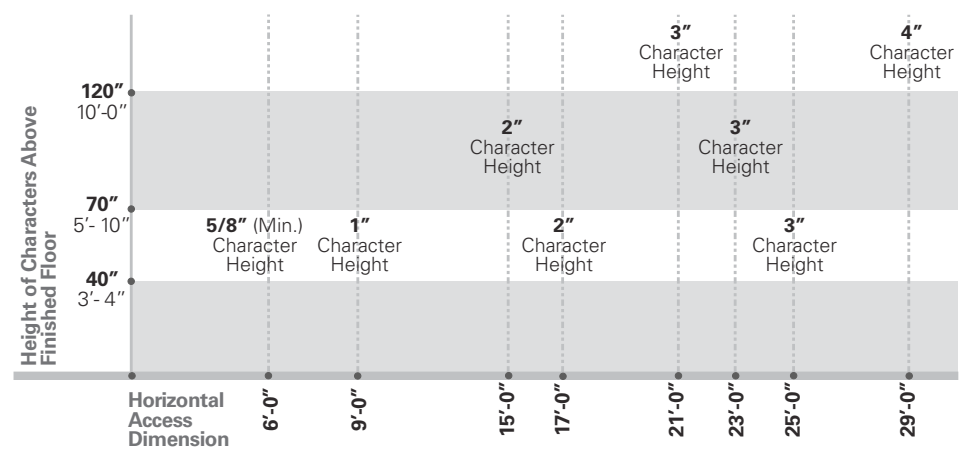

For Visual Characters located between 40" and 70" above the floor:

- With a horizontal access of 72" or less, text height can be as small as 5/8"
- In those unusual situations where access to the sign is restricted by a counter, an escalator, etc., and the reader cannot get within 72" of the sign, 5/8" text height will increase 1/8" per foot for each foot over 72"

For Visual Characters located between 70" and 120" above the floor:

- With a horizontal access of 180" or less, text height can be as small as 2"
- In those unusual situations where access to the sign is restricted by a counter, an escalator, etc., and the reader cannot get within 180" of the sign, 2" text height will increase 1/8" per foot for each foot over 180"

For Visual Characters located higher than 120" above the floor:

- With a horizontal viewing distance of 21 ft. or less, text height can be as small as 3"
- In those unusual situations where access to the sign is restricted by a counter, an escalator, etc., and the reader cannot get within 21 ft. of the sign, 3" text height will increase 1/8" per foot for each foot over 21 ft.

In summary, a viewer will rarely be physically prevented from approaching a sign within 72". It happens, but rarely. In the majority of such cases, the height of the Visual Characters' baseline off the finished floor becomes the deciding factor.

Visual Characters | Stroke Thickness and Character Proportion

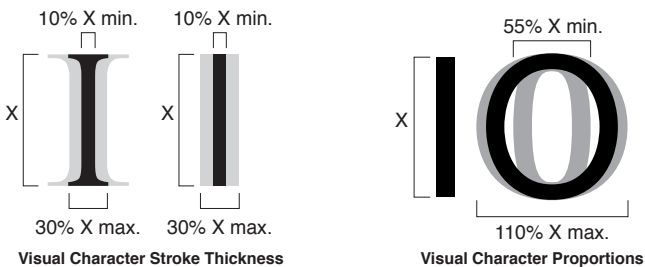

Visual Character Stroke Thickness

- Regular, normal, medium, or bold weights of most typefaces will fall within the stroke thickness range permitted by the SAD:
 - Stroke thickness of "I" between 10% and 30% of the height of the upper case "I"

- Check to make sure, using the method shown in Chapter 4.0, Calculations.

Visual Character Proportions

- Some condensed and extended typefaces in some weights will be accommodated within the character range permitted by SAD:
 - Character width of "O" between 55% and 110% of cap "I" height
- Check to make sure, using the method shown in Chapter 4.0, Calculations.
- Character proportion requirements are the same for both Raised and Visual Characters.

Visual Character Spacing

- Character spacing requirements for Visual and Raised Characters are different.
- The standard for Visual Character spacing is measured between the two closest points of the upper case "I" and "O".
- This spacing must be between 10% and 35% of the character height as measured on the upper case "I." (§703.5.8)

Visual Characters | Spacing

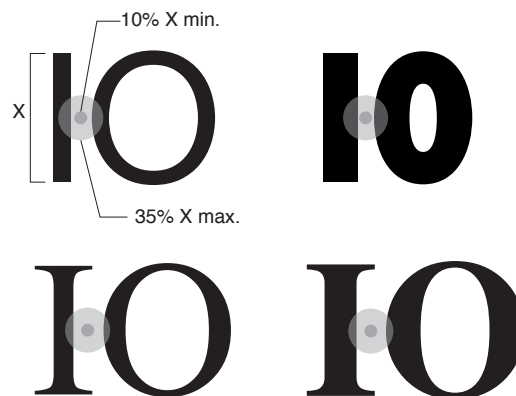

Visual Character Spacing Range

Line Spacing

- Spacing between lines of copy within a message must be a minimum of 135% and a maximum of 170% of the corresponding upper case "I" height (measured from baseline to baseline).
- Line spacing requirements are the same for both Visual and Raised Characters.
- To more effectively distinguish between multiple messages on one sign, line spacing between each message can be greater than 170%

Visual Characters | Multiple Line Spacing

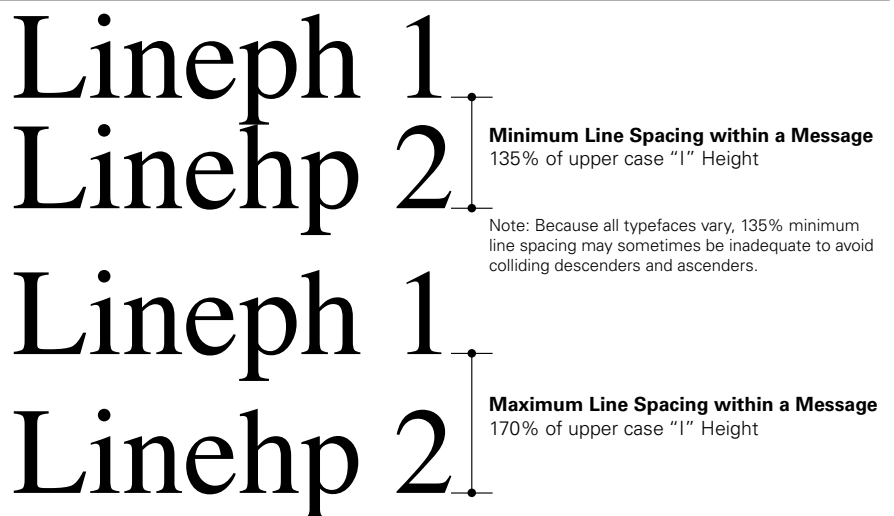

Acceptable Visual Character Typefaces

Note: This list represents only a few of the many acceptable Visual Character typefaces.

Acceptable Visual Character Typefaces | Samples

Adobe Garamond Pro Regular

ABCDEFGHIJKLMNOPQRSTUVWXYZ 1234567890

Bodoni

ABCDEFGHIJKLMNOPQRSTUVWXYZ 1234567890

Century Schoolbook

ABCDEFGHIJKLMNOPQRSTUVWXYZ 1234567890

Eurostile Medium

ABCDEFGHIJKLMNOPQRSTUVWXYZ 1234567890

Frutiger 55 Roman

ABCDEFGHIJKLMNOPQRSTUVWXYZ 1234567890

MetaBook Roman

ABCDEFGHIJKLMNOPQRSTUVWXYZ 1234567890

Univers 57 Condensed

ABCDEFGHIJKLMNOPQRSTUVWXYZ 1234567890

1.3.4 Signs with Combined Raised and Visual Characters

(§§703.2, 703.3, 703.4, 703.5-Exception)

The SAD permits the combined use of Raised Characters and Visual Characters, provided that the combined characters:

- Conform with the Raised Character requirements for depth, case, style, character proportions, character height, stroke thickness, character spacing, and line spacing
- Are accompanied by Braille as required by Section 703.3
- Meet installation height and location requirements in Section 703.4
- Conform with the Visual Character requirements for finish and contrast, and for a minimum 5/8" character height

Combined Raised/Visual Characters on a Single Sign



Combined Raised/Visual Characters required to contrast with background; 5/8" minimum height

1.3.5 Signs with Separate Raised and Visual Characters (§§703.1, 703.2.5-Exception, 703.5)

One of the significant new aspects of the SAD is the inclusion of signs that have separate Raised and Visual Characters, an option that makes multiple design alternatives possible. Previously, signs identifying a permanent room or space were required to be read by touch and by sight together, resulting in conflicts inherent in combining the two methods of communication.

In the case of identification signs using Visual Characters, the SAD permits duplicate Raised Characters to be smaller and more discreet. The SAD also specifies:

- On signs where separate Visual and Raised Characters are used, either one single sign with both types of characters, or two separate signs, one with Visual and one with Raised Characters, may be provided.
- Raised Characters may be reduced to ½" height (§703.2.5-Exception).
- Raised Characters are not required to contrast with their background, but may be painted the same color as the background (§703.5-Exception).

See illustrations, next page.

Separate Visual Characters and Raised Characters on a Single Sign

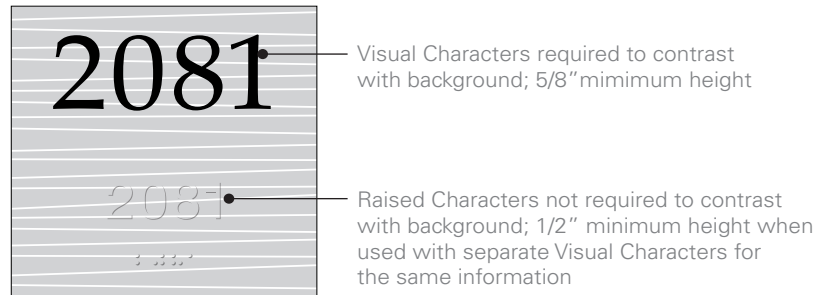

Separate Visual Characters and Raised Characters on Separate Signs

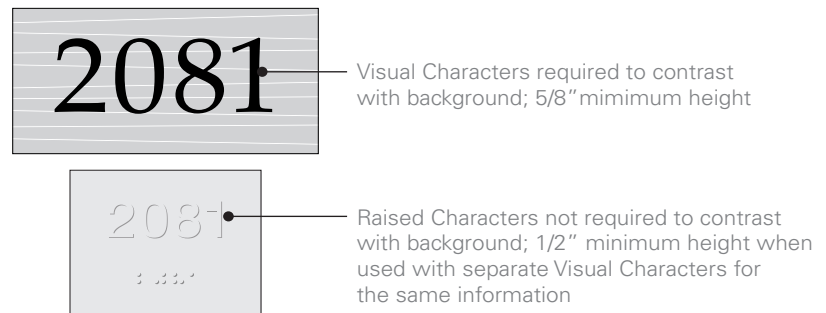

1.3.6 Pictograms Required in Special Instances (§§216.2, 703.6.1)

Pictograms are not required for most uses, except for the International Symbol of Accessibility (ISA or "wheelchair" symbol), which signifies accessible facilities (see Section 1.3.7). However, if a pictogram is used to identify a permanent room or space, it must meet specific requirements:

- Located on a minimum 6" high field; field width can vary.
- No Raised or Visual Characters or Braille on this field.
- Raised Character descriptors must be located below the pictogram (with Braille below the Raised Characters).
- Pictograms are not required to be raised.

See illustration, next page.

Pictogram Requirements

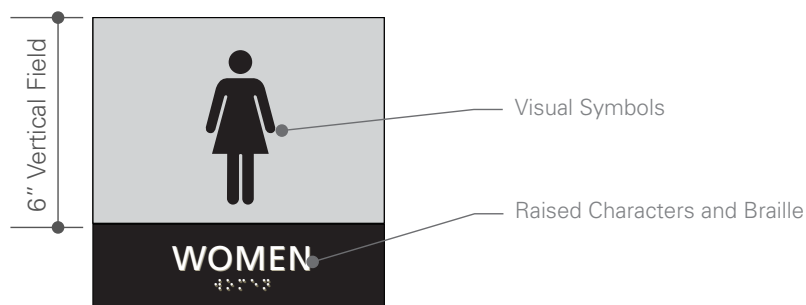

1.3.7 Symbols of Accessibility

(§§213.2 Exception 3, Advisory 216.2, 216.4 – 216.12, 502.6, 703.7)

SAD Section 703.7 contains requirements for four symbols of accessibility:

- International Symbol of Accessibility (ISA, “wheelchair” symbol)
- International Symbol of TTY
- Volume Control Telephone Symbol
- Assistive Listening Systems Symbol

According to SAD, all symbols of accessibility and their backgrounds must have a non-glare finish, and symbols and backgrounds must contrast with each other, either a light symbol on a dark background or vice versa.

International Symbol of Accessibility | ISA “Wheelchair” Symbol

(§§213.2 Exception 3, Advisory 216.2, 216.4 – 216.8, 216.11, 216.12, 502.6, 703.7.2.1, 703.7.2.1)



International Symbol of Accessibility

(§§213.2 Exception 3, Advisory 216.2, 216.4 – 216.8, 216.11, 216.12, 502.6, 703.7.2.1, 703.7.2.1)

The International Symbol of Accessibility (ISA) is required in several instances:

- When not all restrooms or bathing facilities, entrances, or elevators in a facility are accessible, as might be the case in an existing or historical building
 - In the above situations, the ISA symbol is placed on accessible restrooms/entrances/elevators and a sign is placed at each inaccessible restroom/entrance/elevator indicating directions to the nearest accessible one (see Chapter 2.0, sections 2.3, 2.4, and 2.5). Note that accessible/inaccessible entrances require a similar response.

- On signs identifying Areas of Refuge (see Chapter 2.0, section 2.2)
- On signs identifying accessible check-out aisles and amusement ride entries (see Chapter 2.0, Sections 2.8 and 2.9)
- On signs identifying accessible parking spaces (see Chapter 3.0, section 3.2)

The SAD contains no suggested text or layout for these signs, as conditions will vary with each specific project.

In contrast to the SAD, the California Building Code requires all accessible features to be marked with the ISA, per the following:

“The International Symbol of Accessibility shall be the standard used to identify facilities that are accessible to and useable by physically disabled persons. Exception: Signs need not be provided for facilities within an adaptable dwelling unit, or within an accessible patient or guest room.”

Few details of the SAD attract SEGD members’ attention and ire as its requirement for use of the ISA pictogram depicted in SAD Figure 703.2.1. Designed by Susanne Koefoed in 1968, it is copyrighted by Rehabilitation International through its International Commission on Technology and Accessibility (ICTA). RI allows its use to all so long as it is not altered. (However, it is interesting to note that the version of the ISA depicted in the SAD does not match the “official” symbol on RI’s website.)

Presumably SAD specifies the RI-style ISA pictogram because it is generally accepted both nationally and internationally. As an alternative to the RI-style ISA—considered by many in the SEGD community to be stigmatizing because it depicts a “stick figure” instead of a pictogram more closely resembling a human being—in the early 1990s SEGD modified the RI-style ISA (and the three other commonly available symbols of accessibility—TTYs, volume control telephones, and hearing loss). Subsequently, a more active ISA figure has been used by some members of the SEGD community. Under the SAD, however, neither the SEGD-style nor the more active-style ISA is allowed for those signs requiring the ISA pictogram. For those signs not specifically required by the SAD to include the ISA pictogram, any variant can be used. But in order to use an alternate design when the ISA is required, the only recourse would be to claim equivalent facilitation per SAD §103.

Alternative Symbols of Accessibility



SEGD Version



Active Version

In July 2012, SEGD submitted a proposal to change the ICC A117.1 Standard on Accessible and Usable Buildings and Facilities to allow minor stylistic variation of the ISA. If the A117.1 Committee approves the proposal and allows the use of variations such as the SEGD accessibility symbols, it is likely that this language will find its way into some state and local building codes and may ultimately be included in an update of the ADA/ABA (Architectural Barriers Act) guidelines.

TTYs (Text Telephones) (§§216.8, 703.7.2.2)

Pictogram | TTY



- Public TTYs must be identified by the International TTY Symbol.
- In addition, directional signs indicating the location of the nearest public TTY must be provided at all banks of public pay telephones not containing a public TTY.
- Where signs provide direction to public pay telephones, they must also provide directions to public TTYs.
- Such signs must meet Visual Character guidelines.

Volume Control Telephones (§§216.9, 703.7.2.3)

Pictogram | Volume Control Telephones



- Telephones with a volume control are identified by a pictogram of a handset with radiating sound waves on a square field.
- Such signs must meet Visual Character guidelines.

International Symbol of Hearing Loss (§§216.10, 703.72.3)

Pictogram | International Symbol of Hearing Loss



- The international Symbol of Hearing Loss must be displayed where assistive listening systems are required (e.g., theaters), informing patrons of the availability of electronic assistive devices.
- These signs must meet Visual Character guidelines.

1.3.8 Other Interior Visual Signs

Overhanging and Protruding Objects (§307.2)

- Although SAD no longer restricts overhead visual signs to characters at least 3" high, the clearances required for overhanging and protruding objects themselves are still in effect.
- Overhanging (e.g., suspended) and protruding signs or objects must meet Visual Character requirements.

Chapter 2 of SAD, Scoping Requirements, includes requirements for several special sign situations.

Other Interior Visual Signs | Overhanging and Protruding Objects

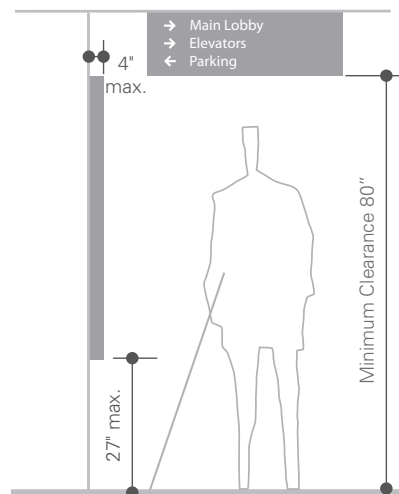

Special Sign Situations | 2.0

2.1 Exit Doors (§216.4.1)

- This is one of the few places (if not the only one) where the SAD is proscriptive and states unequivocally that a certain type of sign is required for doors at exit passages, exit discharges, and exit stairways.
- These signs must use Visual and Raised Characters with Braille (§703.2).
- In an advisory, SAD also defines terms:

Exit Passageway: Horizontal exit component that is separated from the interior spaces of a building by fire-resistance-rated construction and that leads to the exit discharge or public way

Exit Discharge: That portion of an egress system between the termination of an exit and a public way

Other Special Situations | Exit Doors

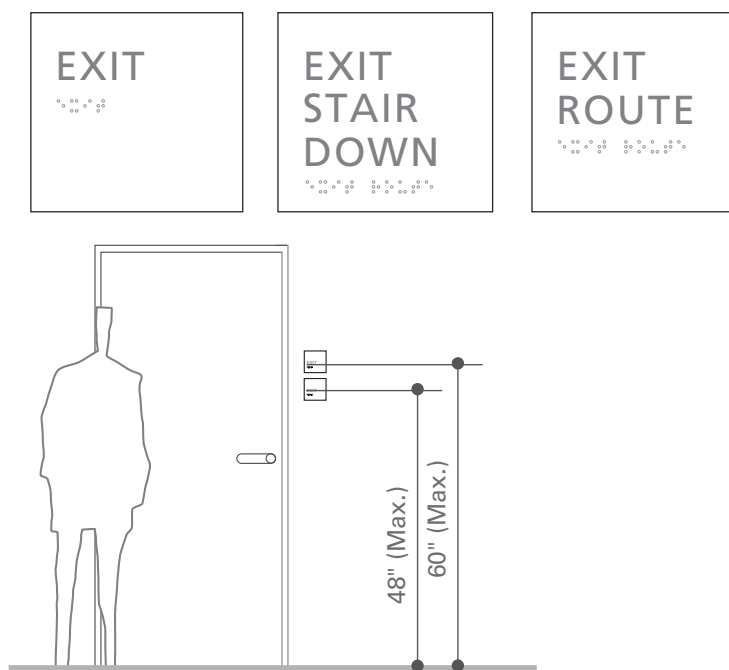

2.2 Areas of Refuge (§216.4.2)

- What SAD refers to as Areas of Refuge were called Areas of Rescue Assistance in the original ADAAG. There is no difference between the two.
- SAD presents the requirements for instructions by reference, meaning that if Areas of Refuge are required by the International Building Code (IBC), 2000 edition (in its §1003.2.16.6), or IBC-2003 (in its §1007.6.4), then instructions are required to be provided in Visual Characters (§703.5), not Raised Characters and Braille.

SAD requires two types of signs at Areas of Refuge:

- Instructions including:
 - Directions to other means of egress
 - Persons able to use the exit stairway as soon as possible, unless they are assisting others
 - Information on planned availability of assistance in the use of stairs or supervised operation of elevators and how to summon such assistance
 - Directions for use of the emergency communications system
 - These instructions **not** required to be tactile or a specific size

Other Special Situations | Areas of Refuge Instructions

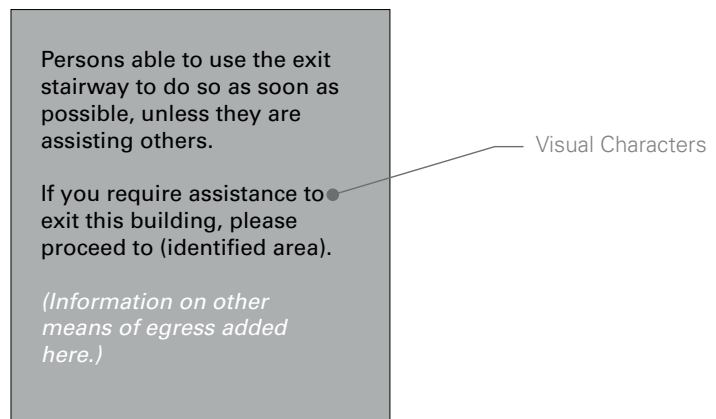

- Identification:
 - Each door providing access to an Area of Refuge from an adjacent floor area must be identified by a sign stating AREA OF REFUGE, using Raised Characters and Braille and the International Symbol of Accessibility (ISA) which is not required to be raised
 - If an illuminated EXIT box is required, an additional illuminated Area of Refuge sign must also be provided.

See illustration, next page.

Other Special Situations | Area of Refuge Identification

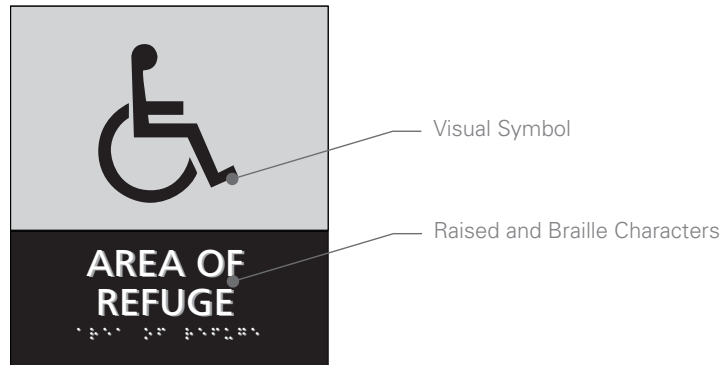

-
- In addition, signs indicating the location of accessible egress are required at elevators and exits that do not provide such accessible egress. This situation will probably never be found in a new building, but may occur in an existing, altered, or historic one.

2.3 Entrances (§216.6)

- SAD requires directional signs (with Visual Characters) indicating the directions to an accessible entrance from inaccessible building entrances. Similar to the requirement for accessible and inaccessible egress, this will probably occur only in an existing, altered, or historic building.
- SAD also requires the use of an ISA on the accessible entrance.
- In California, however, all accessible entrances are marked with an ISA, whether or not there are inaccessible entrances in the facility. In fact, in California, all accessible building features (such as restrooms) are required to display the ISA.

Entrances | Accessible Entrance Directional

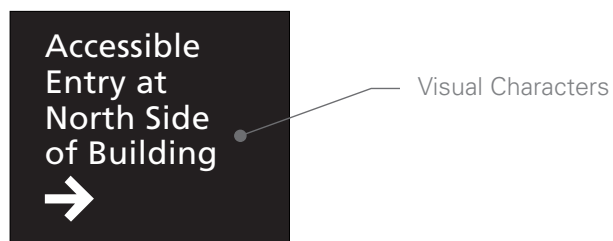

2.4 Elevators (§216.7)

- SAD requires the ISA to be placed on an accessible elevator if all elevators in the facility are not accessible.

Elevators | Accessible Elevator Directional

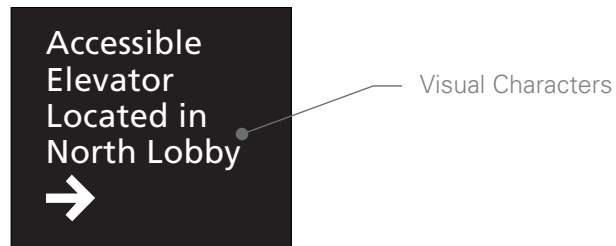

2.5 Toilet and Bathing Rooms (§216.8)

- SAD requires the ISA to be placed on an accessible toilet or bathing room if all toilet and bathing rooms in the facility are not accessible.
- It also requires directional information from inaccessible toilet and bathing rooms to accessible ones.

Toilet and Bathing Rooms | Accessible Location Directional

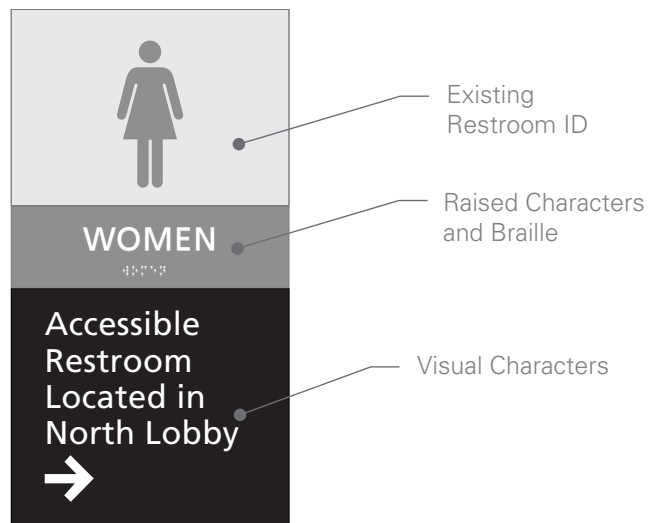

2.6 TTYs (§216.9)

- SAD requires the International Symbol of TTY to appear on public TTYs.
- It also requires directional information from phone banks where TTYs are not present to accessible TTYs, using Visual Characters and the International Symbol of TTY.
- In addition, where signs provide directions to public pay telephones, the signs must also provide directions to public TTYs using Visual Characters and the International Symbol of TTY.

TTY | Location Directional

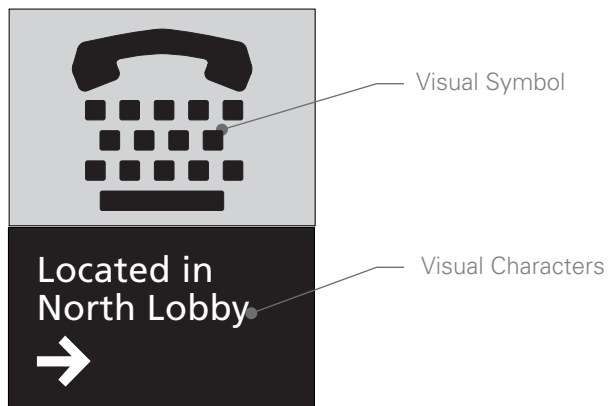

2.7 Assistive Listening Systems (§216.10)

- SAD requires that the Assistive Listening System pictogram appear at each assembly area informing patrons of the availability of an assistive listening system. Such signs use Visual Characters.
- Where present at ticket offices or windows, the Assistive Listening System pictogram need not be present at every assembly area.

ASL/ Assistive Listening Devices

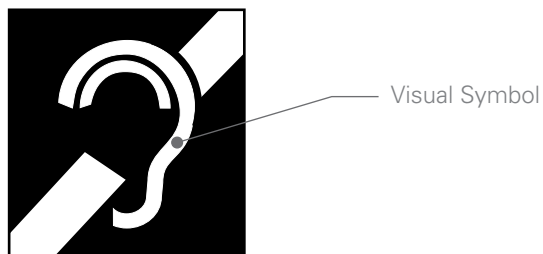

2.8 Check-Out Aisles (§216.11)

- Where more than one check-out aisle is provided, accessible check-out aisles must be identified by the ISA.
- Exception: When all check-out aisles are accessible, the ISA is not required to be displayed.
- Where check-out aisles are identified by numbers, letters, or functions, signs identifying accessible aisles (e.g., by means of the ISA) must be in the same location as such identification.

Check-Out Aisles | Accessible Identification

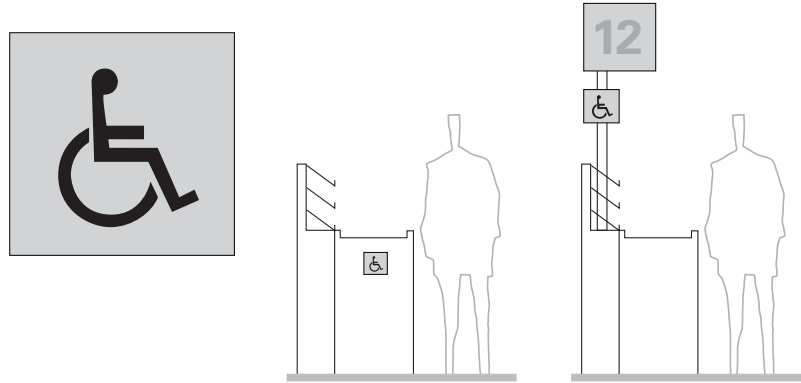

2.9 Amusement Rides (§216.12)

- Signs identifying the type of access provided on amusement rides must be provided at entries to queues and waiting lines.
- Where accessible unload areas also serve as accessible load areas, signs indicating their location must be provided at entries to queues and waiting lines.

Amusement Rides | Accessible Identification

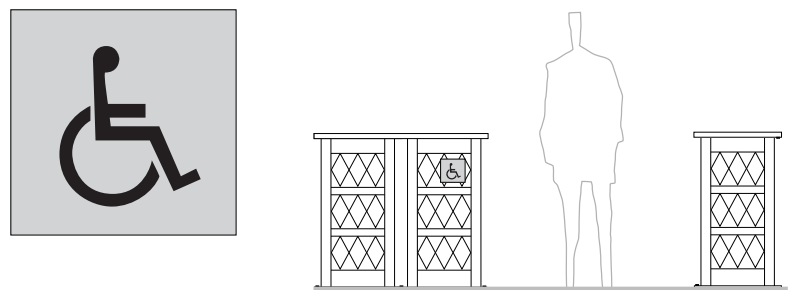

2.10 Floor Designation on Elevator Door Jambs/Hoistways (§4072.3.1)

Floor Designations must be provided on both jambs of elevator hoistway entrances. They also must be provided in both Raised Characters and Braille. Raised Characters must be a minimum of 2" high. A raised star must additionally be provided on both jambs at the main entry level.

Other Special Situations | Elevator Door Jambs/Hoistways
| Floor Designation

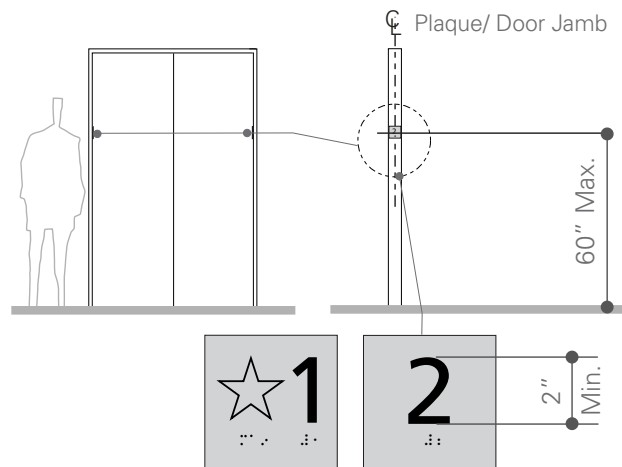

2.11 Car Designation on Elevator Door Jambs/Hoistways (§4072.3.2)

Destination-oriented elevators must be identified on both jambs of the hoistway immediately below the Floor Designation. Car Designations must be provided in both Raised Characters and Braille. Raised Characters must be a minimum of 2" high.

See illustration, next page.

Other Special Situations | Elevator Door Jamb/ Hoistways | Car Designation

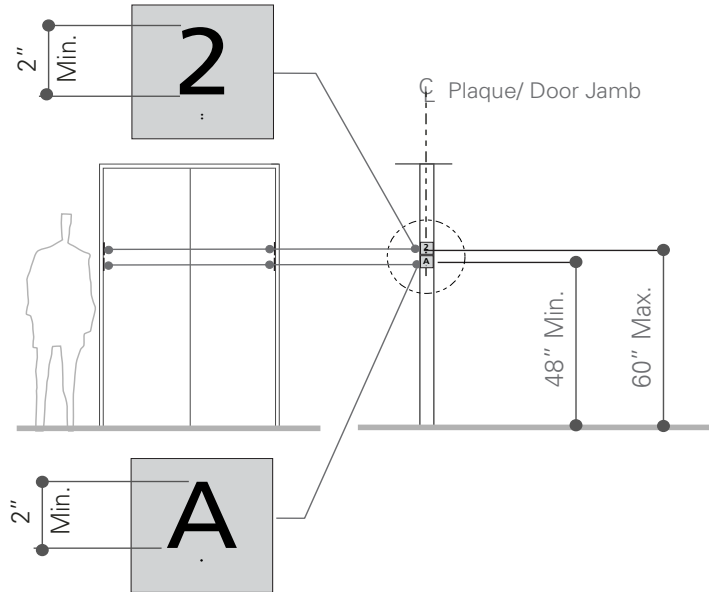

Exterior Signs | 3.0

3.1 Introduction

In general, the SAD is primarily concerned with interior signs, concentrating on the identification of interior permanent rooms and spaces. However, certain interior rooms or spaces have exterior doors, triggering the requirements for Raised Characters and Braille. Typical examples include a restroom at a zoo or a classroom accessed from an exterior breezeway. Both are interior spaces that may have at least one entrance that leads from the outdoors.

In addition, SAD includes requirements for signs or objects protruding into paths of travel in both interior and exterior environments.

3.2 Accessible Parking Signs (§502.6)

SAD includes only three requirements for accessible parking signs:

- Signs must be mounted 60" minimum from the finished floor or ground surface to the bottom of the sign, so they are visible when a vehicle is parked in the space.
- The International Symbol of Accessibility must appear on the sign.
- Signs identifying van parking spaces must include the text, "Van Accessible."

However, these are the types of signs most often modified by state-level accessibility law. This may be because of the sign type's high visibility. Check with the accessibility authorities in your state because it is likely that there are peculiarities. Common state requirements include standard designs and colors, regulatory citations, and more specific restrictions on mounting height.

SAD's Scoping Requirements chapter provides some exceptions to accessible parking sign requirements (§216.5):

- Where there are four or fewer parking spaces, including accessible parking spaces, identification of the accessible parking spaces is not required.
- In residential facilities, where parking spaces are assigned to specific dwelling units, identification of accessible parking spaces is not required.
- Either of these exceptions may be overruled at the state or local level. It's always best to confirm.

Exterior Signs | Accessible Parking Signs

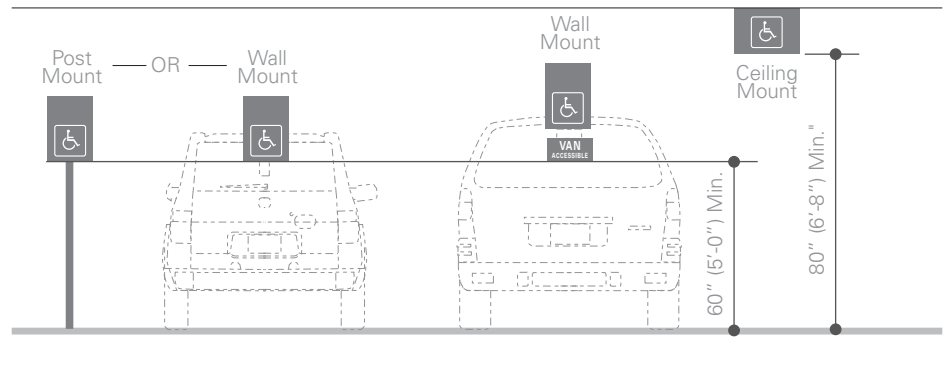

Calculations | 4.0

4.1 Contrast Calculations

Calculations | Contrast

Research indicates that signs are more legible for persons with low vision when characters contrast with their background by at least 70%.

Contrast in percent shall be determined by:

Contrast = $[(B1 - B2)/B1] \times 100$ where B1 = light reflectance value (LRV) of the lighter area and B2 = light reflectance value (LRV) of the darker area.

LRV Value Foreground Color (B1)	LRV Value Background Color (B2)	Contrast
87	4	95%

Note: In any application both white and black are never absolute; thus, B1 never equals 100 and B2 is always greater than 0. In this example, the lighter color, white, has an LRV of 87%. The darker area, black, has an LRV of 4%.

4.2 Measuring Raised and Visual Characters

Calculations | Raised and Visual Characters

Always measure the height of the upper case "I", which is a flat or straight character . . .

- Measure the "I" for:
- Character height (RC & VC)
 - Stroke thickness (RC & VC)
 - Character spacing (VC only)
 - Line spacing (RC & VC)



. . .because round characters are always higher in relation to flat/straight characters

- Measure the "O" for:
- Character proportion/width (RC & VC)

- Measure between the "IO" for:
- Character spacing standard (VC only)

4.3 Measuring Raised and Visual Character Proportions

Calculations | Raised and Visual Character Proportions

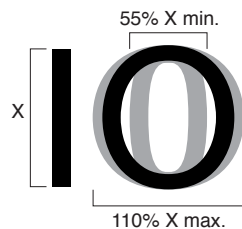

Raised and Visual Character Proportion Range

4.4 Measuring Raised Character Stroke Thickness

Calculations | Raised Character Stroke Thickness

10% X min.
(no min. required, but SEGD
recommends 10% X min.)

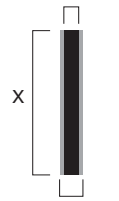

Stroke Thickness

4.5 Measuring Raised Character Spacing

Calculations | Raised Character Spacing

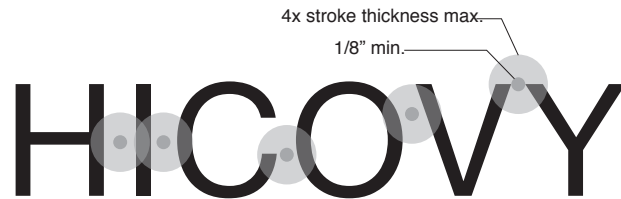

Character Spacing Range

4.6 Measuring Visual Character Stroke Thickness

Calculations | Visual Character Stroke Thickness

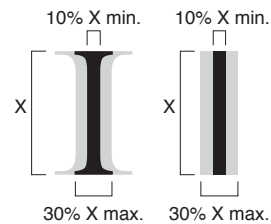

Visual Character Stroke Thickness

4.7 Measuring Visual Character Spacing

Calculations | Visual Character Spacing

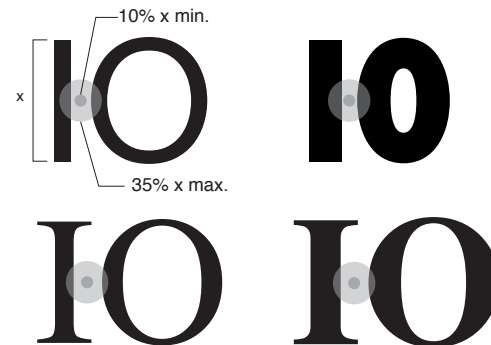

Visual Character Spacing Range

Frequently Asked Questions | 5.0

This chapter addresses some common questions and concerns about accessible signage. It will be amended in the future as necessary. Additional resources include ADA-related threads on SEGDTalk, SEGD's members' open forum.

1. When is a project required to follow the new Standards for Accessible Design?

As with all accessibility questions, insure that you are in synch with an overall project code compliance plan. Coordinate with the architect and the client to make sure you are all proceeding in the same direction.

That said, following is the complete text of the Department of Justice's final rule on the question, with the most relevant sections extracted.

§ 36.406 Standards for new construction and alterations.

- (1) New construction and alterations shall comply with the 1991 ADAAG if the date when the last application for a building permit or permit extension is received by the State, county, or local government before September 15, 2010, or if no permit is required, if the start of physical construction or alterations occurs before September 15, 2010.
- (2) New construction and alterations shall comply either with the 1991 ADAAG or with the 2010 SAD if the date when the last application for a building permit or permit extension is received by the State, county, or local government on or after September 15, 2010, and before March 15, 2012, or if no permit is required, if the start of physical construction or alterations occurs on or after September 15, 2010, and before March 15, 2012.
- (3) New construction and alterations shall comply with the 2010 SAD if the date when the last application for a building permit or permit extension is received by the State, county, or local government on or after March 15, 2012, or if no permit is required, if the start of physical construction or alterations occurs on or after March 15, 2012.
- (4) "Start of physical construction or alterations" does not mean ceremonial groundbreaking or razing of structures prior to site preparation.
- (5) Noncomplying new construction and alterations.
 - (i) Newly constructed or altered facilities or elements that were constructed or altered before March 15, 2012, and that do not comply with the 1991 ADAAG shall, before March 15, 2012, be made accessible in accordance with either the 1991 ADAAG or the 2010 SAD.
 - (ii) Newly constructed or altered facilities or elements that are constructed or altered on or after March 15, 2012, that do not comply with the 1991 ADAAG shall, on or after March 15, 2012, be made accessible in accordance with the 2010 SAD.

2. Where in the SAD does it say which standards apply to what sign types?

The best hiding place is always in plain sight. That's certainly the case with the signage guidelines in the Standards for Accessible Design.

The temptation is to flip immediately to Chapter 7, Communication Elements and Features, and there it says in bold type, "703 Signs." But wait, there's more:

- Areas of Refuge (§§216.4.2, 216.4.3)
- Forward and Side Reach Ranges from Wheelchairs (§§308.2.1, 308.3)
- Protruding Objects (§307)
- Elevator Identification and Buttons (§§407.2.3, 407.4.7.1)
- Parking Space Identification (§502.6)
- Bus Signs (§810.4)
- Rail Station Signs (§810.6)
- Clocks (§810.8)

But the biggest "hidden" secret in plain sight is Chapter 2, "Scoping Requirements."

That's where SAD states which standards apply to what sign types in §216 – Signs. For example, that's where it states, by reference to Chapter 7, that only signs identifying permanent rooms and spaces are required to utilize Raised Characters and Braille.

Many code officials are not aware of the dual nature of the signage or other requirements either and that's why a lot of confusion results. Often, this is where the too-common insistence on Raised Characters and Braille on directional signage comes from. A respectful reminder will, many times, correct the situation.

Footnote: A question often asked in the design community is, "Why don't they just put all the sign stuff in one place so we can actually find it?"

The answer is that signage is a comparatively small part of the entire document and, more to the point, it shares a lot of aspects with other sections. For example, protruding objects aren't always signs.

It's common for regulations to be written in the format of scoping (or, *which* applies to *what*) being separate from all similar technical requirements gathered together under several common headings.

To put it another way, regulations are like architectural specifications: in order to prevent errors and facilitate updating, a requirement is normally only specifically described once and then mentioned only by reference in the rest of the document.

3. What is the definition of a permanent room? What's "permanent"?

This is a question that has puzzled the profession and industry since the inception of the ADA. There still doesn't seem to be a specific definition in the SAD of what constitutes a permanent room or space.

Searching for a specific definition of permanent is sometimes attempted with a view to justify not marking a room or space or, at least, marking it via a less costly (i.e. "non-tactile") graphic method. In truth, if a room is identified, by a room number or by its name in common use, the correct response is to use Raised Characters and Braille.

Remember that the SAD (and the ADAAG before it) rarely mandates a sign at a specific location. It literally says, *if you place a sign at a location, then*, depending on the function of the sign, it must conform to certain guidelines.

Other regulations often mandate signs, such as the case of a state health code requiring restroom identification. In these and similar cases, SAD guidelines are triggered.

The upshot is that, if a sign is not otherwise required, it doesn't need to exist, thereby saving 100% of the cost of the sign.

To respond directly to the initial question, because there is no specific definition, the answer will probably be closer to, *Not Temporary*, as obvious as that sounds. Temporary signs are defined in the SAD scoping section (§216.1) as existing seven days or less and exempted from its provisions. It goes further in the next paragraph (§216.2) to state:

"Interior and exterior signs identifying permanent rooms and spaces shall comply with 703.1, 703.2 and 703.5..."[the requirements for Raised Characters and Braille]

An adjacent advisory drives the point home:

"Advisory 216.2. Designations. Section 216.2 applies to signs that provide designations, labels or names for interior rooms or spaces where the sign is not likely to change over time. Examples include interior signs labeling restrooms, room and floor numbers or letters, and room names. Tactile text descriptors are required for pictograms that are provided to label or identify a permanent room or space. Pictograms that provide information about a room or space, such as 'no smoking,' occupant logos, and the International Symbol of Accessibility, are not required to have text descriptors."

In sum, it's not a good idea to get creative with what is a permanent room or space. Unless the use is very temporary, if a sign is used to identify it, then some portion of it will need to use Raised Characters and Braille.

4. Why are requirements in the SAD referred to as “guidelines” and not “regulations” even though I have to follow them anyway?

The word “guideline” appears often in the SAD, for good reason. It’s not the same as “regulation.” The use of “guideline” reinforces that the Americans with Disabilities Act is fundamentally civil rights legislation.

In the case of civil rights legislation, there is no such thing as a regulation, because only a judge ruling on a specific case can decide if a certain action (or sign) was enough to prevent discrimination on the basis of disability. So, it’s certainly true that “You can’t comply with the ADA, you can only meet its provisions.”

You can imagine (or remember) the consternation that ensued in the architectural and construction industries when the impact of the ADA became known. Before, buildings were subject only to regulation, black and white statements of what was permitted and what was not. Now there was an entirely new layer of jurisprudence, not to mention uncertainty.

The individual states were required to adopt the “guidelines” into their building codes. Now it became possible to “comply” with the state statute. Certain states, California and Texas among them, introduced enforcement procedures that allowed the Department of Justice to certify that the accessibility codes were “safe harbors,” meaning that “complying” with that states’ code is equivalent to “meeting” the letter and spirit of the ADA.

5. What guidelines are in place for interactive digital signage or cash machines?

Although there are no specific references in either the 1991 ADAAG or 2010 SAD guidelines for interactive digital signage height or reach range requirements, the following sections in the SAD can be interpreted to address the question.

“Interactive digital signs must be installed at mounting heights that make it easily seen and used by the general public. The availability of a touch element indicated by the International Symbol of Accessibility (ISA) at the bottom of the display will allow a disabled individual to activate the software to move all interactive elements to the bottom portion of the display. All interactive elements should then be within the height and reach guidelines. ”

All appropriate areas of §308, Reach Ranges, should be followed as well as protruding object referenced in §307.2.

Section 308, Reach Ranges, provides unique direction in §308.1 for “operable parts” designed specifically for children, based on age groups up to 12 and ranges of 36” to 44” maximum and 16” to 20” minimum from the finished floor.

Forward Reach

Subsection 308.2, Forward Reach, provides direction for both unobstructed reach, at 48" maximum and 15" minimum, and obstructed reaches defined by specific obstruction depths with a 48" maximum for <20" deep obstructions and a 44" maximum for 20" to 25" deep obstructions.

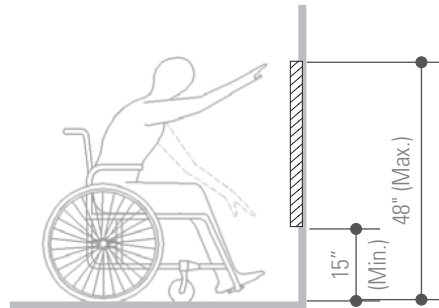

Side Reach

Section 308.3, Side Reach, provides similar direction on unobstructed reach, at 48" maximum and 15" minimum. The obstructed reach, obstructions defined as no more than 34" high and 24" deep, require a 48" maximum where reach depth is 10" or less and 46" for reach depths between 10" and 24."

This is a significant change from the 1991 ADDAG in that, now, both forward and side wheelchair reach limits are set at 48." In ADAAG, the front reach range was set at 48" but the side reach limit was set higher, at 54."

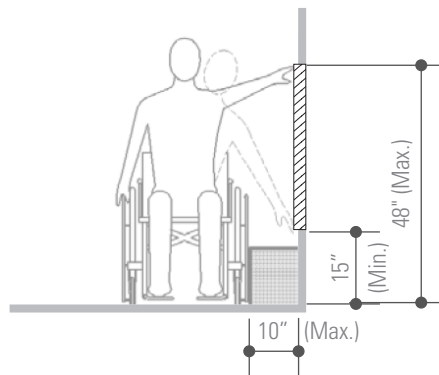

6. Is 70% contrast still required between characters or pictograms and their backgrounds?

The 70% contrast “rule” is no longer mentioned in the guidelines. The requirement now is merely for *light-on-dark* or *dark-on-light*, leaving it up to the designer to decide what constitutes proper contrast. However, the 70% calculation is still a good rule of thumb to follow to determine legibility.

The formula used for calculating contrast is a simple proportion, basically the difference in Light Reflectance Values (LRV) between the lighter color and the darker color divided by the LRV of the lighter color.

Although it is possible to find a laboratory that can test a paint sample and establish an LRV, in practice it is very difficult to find a facility competent to perform the test or to measure LRV's in the environment.

Signs that use natural materials such as wood, stone, or metal are not easy to measure.

LRVs for standard colors may be obtained from major sign and sign paint manufacturers. LRVs for custom colors may be estimated using the LRV values for similar colors found in a commercial paint fan deck.

7. Are there any requirements in SAD for signs at transportation facilities?

The SAD, as well as the previous ADAAG, has specific requirements for transportation facility signage. Located in Section 810 of the SAD, these important requirements are often unintentionally overlooked by the EGD community.

If you're involved with transportation facility design or construction, it's a good idea to familiarize yourself with these requirements, which focus on the following kinds of signage and graphics:

- Bus Signs (§§810.4, 810.4-Exception)
- Rail Station Signs, including entrances, routes and destinations, and station names (§§810.6, 810.6-Exception, 810.6.1, 810.6.2, 810.6.2-Exception, 810.6.3)
- Clocks (§810.8)

Appendix | 6.0

Appendix | Additional Acceptable Typefaces

Group A: Acceptable for Raised Characters Only

Helvetica Neue 45 Light
Univers 45 Light
Frutiger 45 Light

Note 1A: *These typefaces have thinner stroke widths than the 10% minimum recommended by the SEGD. The thinner the stroke width, the more difficult it is to conform with the 4x stroke width maximum character spacing requirement for Raised Characters.*

Note 2A: *All of the typefaces in Group B are also acceptable for Raised Characters only.*

Group B: Acceptable for Combined Raised and Visual Characters

Frutiger 55 Roman
Frutiger 57 Condensed
Futura Book and Medium
Gotham Book
Helvetica Neue 55 Regular
Helvetica Neue 57 Condensed
Interstate Light and Regular
Interstate Light Condensed and Regular Condensed

Group C: Acceptable for Visual Characters Only

Bodoni Roman and Bold
Bodoni Bold Condensed
ITC Cheltenham Light through Bold
ITC Cheltenham Light Condensed through Ultra Condensed
Didot Regular and Bold
Futura Extra Bold Condensed
Glypha 55 Roman through 75 Black
Goudy Old Style and Bold
Helvetica Neue 65 Medium through 85 Heavy
Sabon Roman and Bold
Times Roman Regular and Bold

Note 1C: *All of the typefaces in Group B are also acceptable for Visual Characters only.*

Additional Notes:

1. *Many different individual fonts within a type family may be acceptable for Raised Characters, Visual Characters, or both.*
 2. *This list of typefaces is for reference only and is not exhaustive. Checking of these and other typefaces for acceptability in the SAD's various usage categories is highly recommended. See Chapter 4.0, Calculations.*
-